



K50 Wood Pellet Stoves



INSTALLATION AND OPERATING INSTRUCTIONS

This appliance is hot while in operation and retains its heat for a long period of time after use. Children, aged or infirm persons should be supervised at all times and should not be allowed to touch the hot working surfaces while in use or until the appliance has thoroughly cooled.

When using the stove in situations where children, aged and/or infirm persons are present a fireguard must be used to prevent accidental contact with the stove. The fireguard should be manufactured in accordance with BS 8423:2002.

TABLE OF CONTENTS

	PAGE NO.
1. Setting the language	3
2. Stanley Pellet Stove Warranty	3
3. Important Operation/ Maintenance Notes	4
4. Installation Checklist	5
5. Technical specifications	6
6. Unpacking	7
7. Installing your Pellet Stove	7
8. Flue / chimney installation	8
9. Electrical connection	8
10. Clearance to Combustibles	8
11. Ventilation & Combustion Air Requirements	9
12. Fuel	9
13. Using the pellet stove	10
14. Remote control	11
15. Control and display panel	11
16. Mode selection	12
17. Setting time and date	12
18. Setting the sleep timer	13
19. Setting the programmer	15
20. User Information	16
21. Combustion settings	16
22. Operation	17
23. Maintenance / glass cleaning	18
24. Weekly maintenance	18
25. Additional cleaning	18
26. Maintenance plan and Log	21
27. Troubleshooting	22
28. Exploded views	23
29. Spare parts list	24
30. Ignition logic flow diagram	25
31. shut down logic flow diagram	26
32. Fixed timer program schedules	26

Setting the Language for the first time.

To set the Language to English on the controller.

Press the menu button until “ set” is displayed beside the menu button.

Press the “ +” button 3 times , display shows “configura.....”.

Press the set button twice until abbreviation for languages in the top and centre of the screen.

Press the “ +” button until abbreviation “EN” is displayed.

Press the Menu button to set the language to English.

STANLEY PELLETT STOVE WARRANTY

CONDITIONS OF WARRANTY

Your Stanley pellet stove is guaranteed against any part that fails (under normal operating conditions) as detailed in the following table with timelines specified from the date of installation of the appliance. If the unit is not installed within six months of date of purchase, the warranty will commence six months from the date of purchase.

Warranty Period	Parts Covered (Parts & Labour unless Stated)
Up to 1 Year	<ul style="list-style-type: none">• Refractory materials (supply only)• Rope seals, glass seals and cement seals.(supply only)• Surface Finish on Seno models.• Burnpot / crucible.• Ceramic glass is covered for Thermal breakage (supply only).• Rust (if reported before installation)• Aesthetic Damage (provided reported on date of receipt)• Electrical components under normal operation.
Up to 2 Years	<ul style="list-style-type: none">• All external casings & enamel finishes (excluding impact damage or damage caused by overfiring). Pictures of damage must be submitted to WS Service Department.

All warranty claims must be reported to the Waterford Stanley Service Department and must be submitted with the product serial number (located on the data plaque at the rear of the product), date of purchase, proof of purchase (if requested) and details of the specific nature of the problem.

The warranty is given only to the original consumer/purchaser only and is non- transferable. The appliance must be installed by a suitable qualified person and installed as per the requirements of the manual. Failure to comply with the Installation requirements or Building Regulations will void your warranty. Waterford Stanley reserve the right to replace any part due to manufacturing defect that fails within the warranty period under the terms of the warranty. The unit must be used for normal domestic purposes only and in accordance with manufacturer's operation instructions.

LIMITS OF LIABILITY

The warranty does not cover:

- * Special, incidental or consequential damages, injury to persons or Property, or any other consequential loss.
- * Any issue caused by negligence, misuse, abuse or circumstances beyond Waterford Stanley's control.
- * Any issue with wear and tear, modification, alteration, or servicing by anyone other than an authorized service engineer.
- * Installation and operational related problems such as draught related issues external to the stove, inadequate venting or ventilation, excessive flue offsets, negative air pressure caused by insufficient burning of improper fuel.
- * Damage caused to the unit while in transit.
- * Discolouration due to over firing, damage caused by impact, damage to baffles caused by over firing and fading of surface finish on casting.
- * Stress fractures on bricks.
- * Rust on cast iron parts unless reported prior to unit being installed.
- * Aesthetic damage, rust & missing parts on units purchased off display.
- * Electrical components where voltage variations are in excess of 10% of nominal 230V

Note: Adequate clearance must be maintained around the appliance to ensure the ease of part removal in the possible event of their damage/failure. Waterford Stanley are not responsible for any costs incurred in the removal of items installed in the vicinity of the appliance that have to be moved to facilitate a part replacement.

IMPORTANT OPERATION / MAINTENANCE NOTES

N.B.: The information in this manual is given as guidance, all local, national or EC regulations must also be complied with.

Before using this appliance, please read all parts of this instruction manual carefully, as the information it contains, is essential in order to use the appliance correctly,

Make sure you fully read and understand the instructions contained in this manual before using the Pellet Stove as a biomass heating unit.

Do not touch the stove especially the control panel with wet or damp hands.

Do not burn fuel with a high moisture content, ie damp pellets.

Do not tamper with the safety devices or adjustment features without prior authorization from Waterford Stanley

During the first firings it is recommended to ventilate the room as an unpleasant (not toxic) odour may be emitted as the paint is completing curement.

Empty the ash container and clean the combustion chamber after burning of every 30kg of pellets.

Check flueways before lighting especially after a shut down period.

Allow adequate air ventilation to ensure plenty of air for combustion at all times.

Never turn off an operating pellet stove unit by disconnecting the electric plug. Disconnecting the plug will prevent the extraction of combustion fumes;

The only fuel that should be used for operation of the pellet stove are pellets certified by EN 14961-2 grade A1 with a diameter of 6 mm and a length that can range from 10 to 30 mm.

Keep all combustible materials a safe distance away from unit, please see section for clearances to combustibles.

Never use aerosol spray near the appliance when it is in operation.

For safety reasons never leave children or the elderly unaccompanied while stove is in use. Use a fire guard.

This appliance should be regularly maintained by a competent service engineer.

Please keep the packing materials away from children;

The manufacturer will not be responsible for any modifications made to this appliance by or on behalf of the user. The manufacturer will not be responsible for any eventual damage or loss as a result of unauthorised modifications. In the event that parts need to be replaced, only use parts recommended by Waterford Stanley.

INSTALLATION CHECKLIST

Flue System

1. Minimum Flue Height of 2 metres.
2. Tee piece fitted at base of flue.
3. Appliance should be connected using an 80mm connecting flue pipe, increasing to 125mm within 1.5 metres of the appliance
4. Horizontal run of connecting pipe must not exceed 600mm.
5. All flue pipework passing through walls must be sleeved & adequately insulated in line with current Building Regulations.
6. An appliance connected to a chimney must be lined with an 125mm flue liner.
7. The chimney/ flue termination must be located in accordance with building regulations part J.
8. The chimney serving this appliance should not serve any other appliance.
9. Access should be provided to the chimney serving the appliance to allow for cleaning.
10. It is a requirement by Building Regulations to have a carbon monoxide alarm fitted to any room with a solid fuel appliance.
11. A suitable cowl must be fitted at the flue termination to prevent excessive wind effects and rain entering the flue.

Location

11. Clearance to combustible materials must be adhered to as described in the Clearance to Combustible section.
12. The stove must be installed on a floor protector that covers the area under the stove and extends 9" to the front and 6" to the sides.
13. Clearance must be maintained to allow for maintenance and part replacement.

Ventilation & Combustion Air Requirements

14. The room in which the appliance is located should have an air vent of adequate size to support correct combustion (see Ventilation & Combustion Air Requirement Section for specific details).
15. The stove must not be installed in the same room as an extractor fan.
16. External air connection maximum length 600mm of straight pipe only.

TECHNICAL SPECIFICATIONS

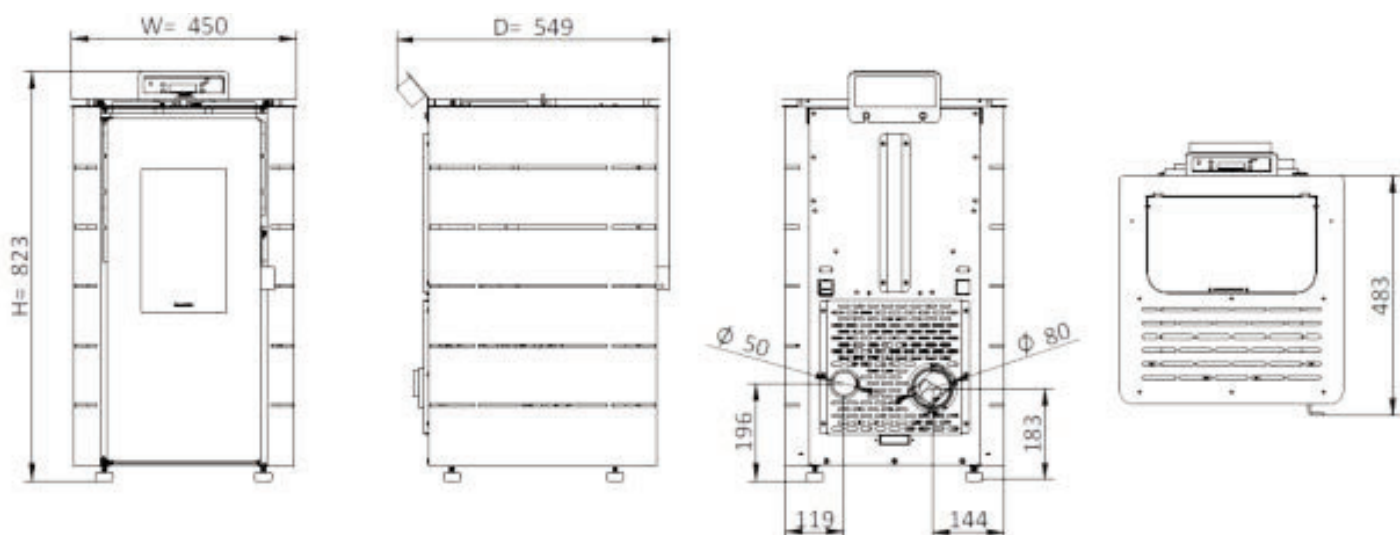

Characteristics	K50	Units
Height	823	mm
Width	450	mm
Depth	549	mm
Flue pipe diameter.	80	mm
Pellet Hopper capacity	11	kg
Maximum heat Input	6,1	kW
Minimum heat Input	3,2	kW
Minimum fuel consumption	0,7	kg / h
Maximum fuel consumption	1,36	kg / h
Rated electrical power	89	W
Electrical power at start (<10 min.)	362	W
Rated voltage	230	V
Nominal frequency	50	Hz
Efficiency at max. input	92	%
Efficiency at min. input	95	%
Maximum flue gas temperature	123	°C
Minimum flue gas temperature	66	°C
CO emissions at max. input	0,01	%
CO emissions at min. input	0,04	%
Mass flow of combustion gases	5	g/s
Flue pressure/ draught.	12	Pa

Tests performed using wood pellets with a calorific value of 4.9 kWh/kg.
The above data was obtained in independent accredited laboratories.

Contents

The package of this unit contains:
Free Standing Pellet Stove K50
Instruction manual
Power cable;
Infrared remote control;
Cleaning bar handle;

Unpacking the Unit

To unpack the equipment, you must first remove the retractable bag that surrounds the cardboard box. Then remove the box, lifting it up, and remove the bag that surrounds the stove and the packaging. To complete the procedure, unscrew the four brackets that secure the unit to the wood pallet (Figure 1).

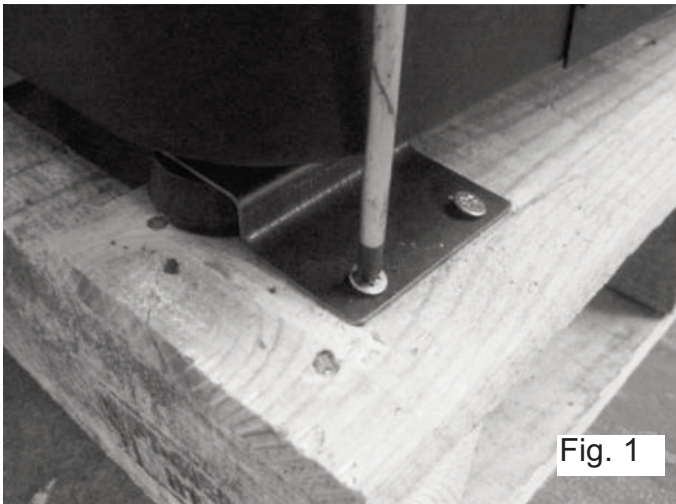

Installing your Pellet Stove

Remove the instruction manual from the package, it must be passed to the homeowner following installation.

Before installing the unit, please follow these steps:

Check immediately after receipt if the delivered product is complete and in good state. Any defects should be noted before installing the appliance.

The unit is equipped with four feet at the base, adjustable in height, allowing for the easy regulation when installing the unit on a non-levelled surface.

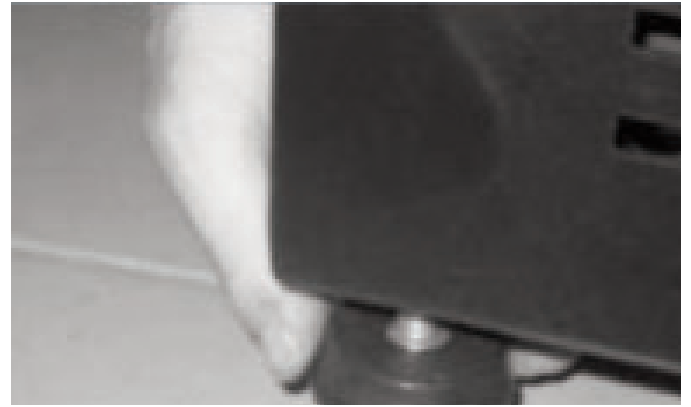

Installation Requirements

- 1 Location, Suitable area to be heated.
Floor support / Hearth.
- 2 Flue connection capable of producing 12pa flue draught.
- 3 Electrical requirements
- 4 Clearances
 - a) To combustibles
 - b) For servicing/ maintenance
- 5 Adequate air supply for combustion/ventilation

Location

The floor should be capable of supporting the weight of the product and hearth.

A solid non combustible hearth of minimum thickness 12 mm, The hearth should extend 150 to the side and 225mm to the front

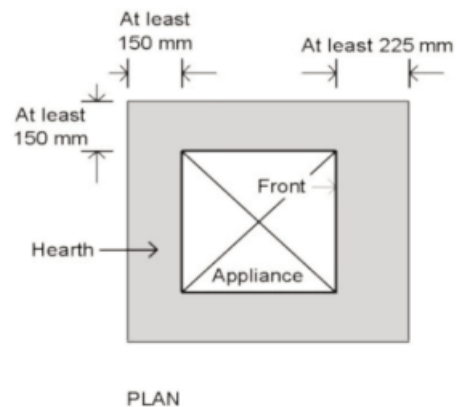

Fig. 2

The appliance should be installed centrally in the area to be heated.

Flue/ chimney installation

The appliance must be connected using a connecting pipe of diameter 80mm. . A Tee piece must be installed at the base of the chimney to allow for cleaning/ inspection. The main section of the flue should be installed using a diameter 125mm flue pipe which must begin within 1.5 metres of the appliance flue outlet

Single wall flue is permitted in the area to be heated, outside of that area the flue must be insulated.

If the flue is to be routed through an existing chimney it can be done using a flexible stainless steel pipe with a register plate at the base of the chimney, the area in the chimney external to the flue liner must be back filled with insulation.

Where the flue pipe is installed external to the dwelling, it must use twin wall insulated stainless steel flue. The flue must have a vertical length of at least 2 metres. A horizontal length is not recommended other than at the rear of the appliance, the horizontal run should be no more than 600mm, on all other sections of flue it is recommended that they make an angle to the vertical of no more than 45 degrees.

The flue termination point/outlet must be above roof level and in accordance with building regulations part J.

IMPORTANT: All sections of the flue pipe must be accessible for inspection, and allow for internal cleaning, removal or replacement.

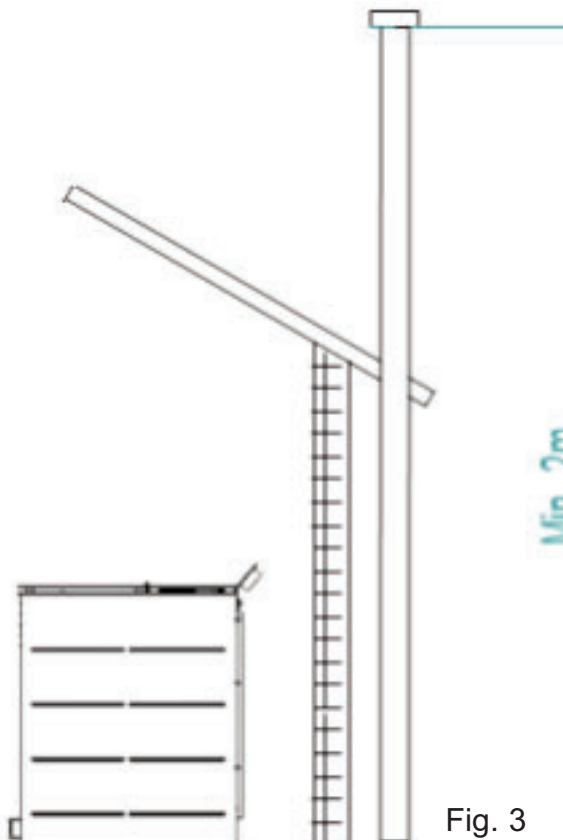

Fig. 3

Electrical connection

Important: The appliance MUST be earthed.

Before installing the appliance, the power supply system must be checked to ensure it has an effective earth circuit.

Important: the power supply cable must be of sufficient cross-section for the power requirement of the appliance.

The supply voltage required for the stove is 220-240 V at 50 Hz. Voltage variations greater than 10% of the rated value may cause irregular operation, or damage to the electrical system. The appliance must be positioned so that the domestic power supply plug remains accessible.

If the power supply cable becomes damaged, switch off the power and have it repaired by an authorised Stanley service agent.

Clearances to combustibles

A clearance to combustibles of 100cm must be maintained above the stove see Fig 5

Fig. 5

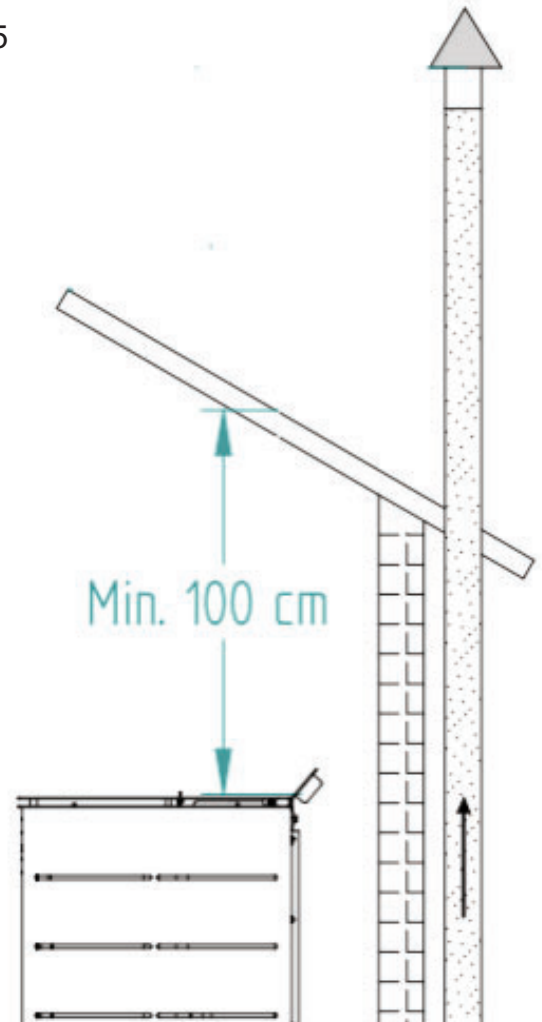

A clearance to combustibles of 50cm must be maintained to either side of the stove, 30 cm to the rear and 150 cm to the front of the stove see Fig 10

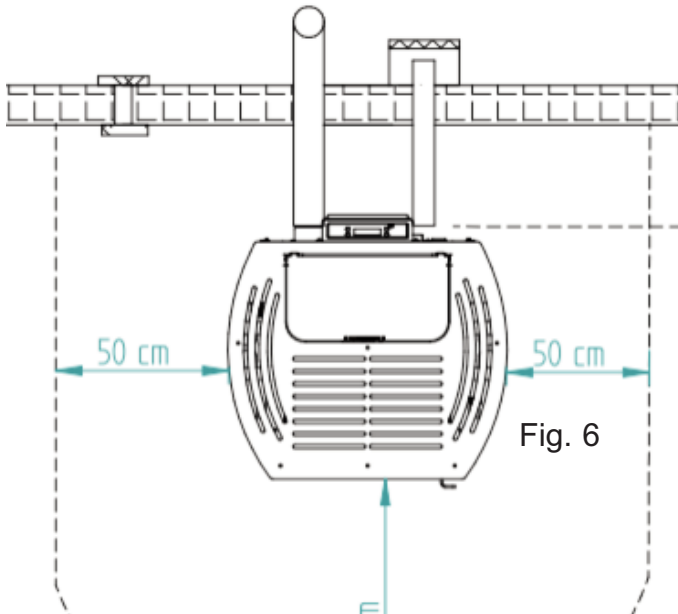

In the event that the product is installed in a non combustible recess, clearances for servicing, must be provided, 200mm to the rear and 300mm to the sides.

VENTILATION/COMBUSTION AIR

The process of combustion requires oxygen, and therefore air. When in operation, the stove draws air through the 50mm diameter intake pipe at the rear of the appliance. The external air can be connected through a straight pipe of maximum length 60cm. Otherwise the appliance will draw air from the room in which case provision must be made for the air requirement providing an air vent in the room. Poor combustion may result if the room is insufficiently ventilated.

A room containing an appliance (other than a room sealed appliance) should have a permanent ventilation opening of

free area of at least:

6,500 mm² where air permeability is greater than 5.0 m³/(hr.m²),

7,050 mm² where air permeability is less than 5.0 m³/(hr.m²).

Where a flue draught stabilizer is used the total free area should be

increased by 300 mm²

for each kW of rated output.

If the stove is located in a room containing another air using appliance, it is essential to provide ventilation equivalent to the sum of the air requirement for all appliances. the stove should not be installed in the same room as an extractor fan.

External Air Connection

To connect the stove to outside air an outside air kit and an offset adaptor can be supplied as an optional extra.

The outside air kit (AOSAVKIT) contains

External air terminal in stainless steel.

100mm diameter aluminium flexible pipe.

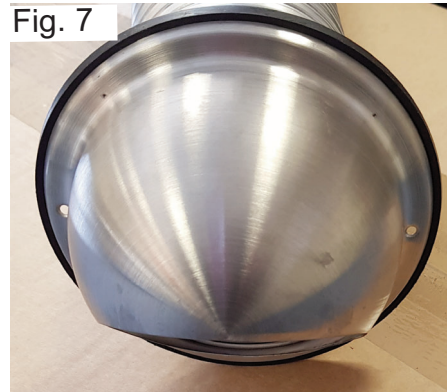

In addition to the outside air kit an offset adaptor (J00276) is required to adapt at the rear of the stove, see offset adaptor fitted to end of flexible pipe.

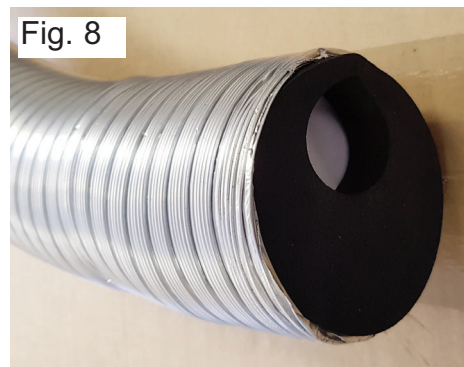

FUEL

The appliance is suitable for use with wood pellets certified to EN 14961-2 grade A1 with a diameter of 6 mm and a length that can range from 10 to 30 mm. As fuel, pellets are completely environmentally friendly, as they are made entirely of natural wood, without glue or other chemical compounds. Pellets have a high calorific value (4.7 to 5.3 kW/kg), and low moisture content.

IMPORTANT: Pellets must be stored in a dry place. Use only good quality pellets, without sawdust.

IMPORTANT NOTICE: The small quantities of sawdust normally present at the bottom of the bags should not be emptied into the tank, but should be held inside the bag while pouring the pellets carefully so that the sawdust remains inside.

If sawdust accumulates in the tank, it should be removed periodically with a vacuum cleaner (with the door open and disconnecting the power plug from the electricity supply), to prevent it entering the loading system and causing serious malfunctions.

Using the Pellet Stove

Before starting up the unit, please check the following:

Ensure the unit is properly connected to the power mains using the 230V AC power cable.



Fig. 9

Check if the pellet reservoir is supplied with pellets. Inside the pellet reservoir is a safety grid to prevent users from reaching the worm screw.

The combustion chamber of the stove and the door are built in steel sheet painted with high temperature paint, releasing fumes during the first ignition due to the cure of the paint. Avoid touching the equipment during the first burn so as not to leave permanent marks on the paint because it's going through a plastic phase during its curing process.

Charging the pellet Wormscrew

Prior to the first use the wormscrew can be primed to make the initial light up easier.

Press the " menu" button twice, followed by repeated pressing of the "+" button until " settings" is displayed.

Press "menu/ set" followed by repeated pressing of the "+" button until " charge pellet" is displayed.

Press "menu/ set" the wormscrew will rotate continuously, continuously monitor the crucible/ burnpot, when pellets begin to drop press "esc" to stop the wormscrew.

The stove has a probe for measuring the room temperature. This probe is attached to the grid on the rear panel. For a good reading of the room temperature, avoid the contact between the end of the probe and the unit surfaces. You may also attach the probe to the wall beside the unit.



Fig. 10

Remote Control

The infrared remote control allows the user to turn the unit ON and OFF, control the fan air-flow and increase or decrease the unit's power level.

Fig. 11



Control and Display Panel

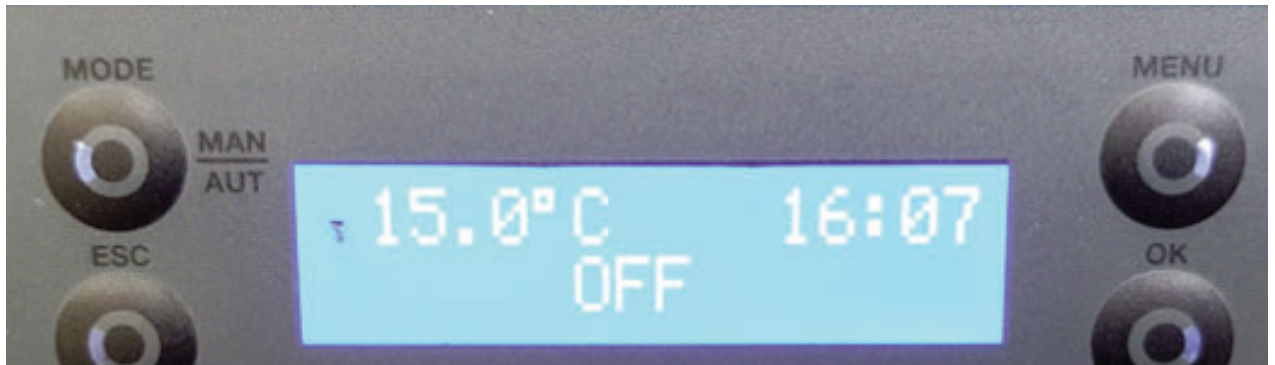

Button	Function
Mode/ Esc	Toggle between manual and automatic mode / escape or exit menus .
Menu / OK when flashing	Access menus / ok -accept value
On / OFF	Start unit when it is off , stop unit when it is on, Resets error messages
Minus sign “-”	scroll menus to te left, increase and reduce the fan speed, increase or reduce the set-point temperature
Plus sign “+”	scroll menus to the right increase or reduce the heat output

Selecting the Manual or Automatic Mode

To select the operating mode, press the “Mode” key to select “Manu” for manual mode or “Auto” for automatic mode.

“Manual mode”: In this mode, the unit will operate at the heat output selected using the “-” key, ranging between 1 (minimum fire) and 5 (maximum fire)

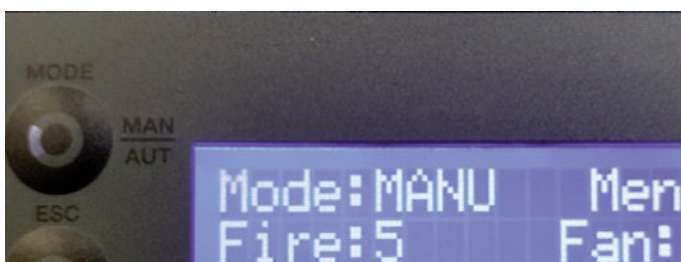

Auto mode: In this mode, the unit is turned on at maximum power until reaching a temperature 1°C above the selected temperature (set point temperature). After reaching the selected temperature, the unit switches to the minimum operating power. The set-point temperature can be set between 5 and 40°C by pressing the “-” key.

The “+” key allows the user to set the fan speed between 1-5 or to “A” for automatic operation.



Setting the Date and Time

Setting the date:
press the Menu key twice until "Day and Time
is displayed.

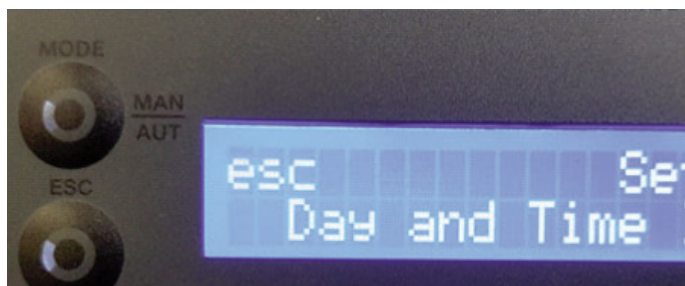

Press "set" to see the following menu:



To set the year press "set". The display starts to flash. Press the "+" or "-" key to select the desired year and then "ok" to confirm.

Press "+" to scroll to the next menu. The "Month" is displayed.



To set the "month" press "set". The display starts to flash. Press the "+" or "-" key to select the desired month and then "ok" to confirm

Press "+" to scroll to the next menu. The "Day number" is displayed. This is the date / day of the month.

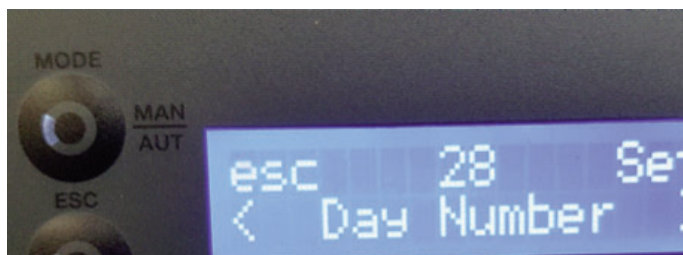

To set the "Date" press "set". The display starts to flash. Press the "+" or "-" key to select the desired date and then "ok" to confirm

Repeat the same steps to set the Day of the Week ,Hour and minutes.

Setting the sleep Timer

This option is only displayed on the menu when the stove is on. Press the " menu " button" until " day and time " is displayed , then press the "ok " button twice which will scroll to the right to show the display as below



Press "set". The display starts to flash. Select the desired time using the "-" and "+" keys. After choosing the time, press "ok" to confirm. Press " esc" when finished to get back to the normal display



The display will then switch between the normal screen and a screen similar to above showing the current time and the sleep time at which the stove will switch off.

Setting the Programmer.

The unit is equipped with a timer that allows the unit to be turned on or off at specified times.

This can be set up by loading one of 10 preset profiles in the software P01- P10.

Alternatively the unit can be programmed manually with up to 6 on/ off times per day.



When the unit is set to switch on and off using the programmer the display will flash between the on/ off screen and a screen similar to above.

To enable the timer press "set". The "enable" menu is displayed. The timer may only be activated after setting the configurations, as shown in the following paragraph..

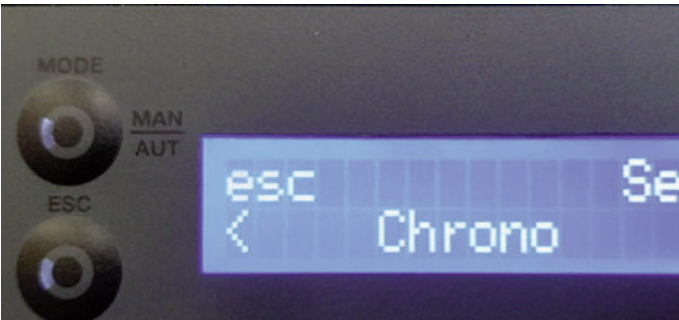

To activate the Timer mode, press "Set" the display starts to flash. Press the "+" or "-" key to select "On" or "Off" and then "Ok" to confirm. Press the "+" key to scroll to the "Load profile" menu.

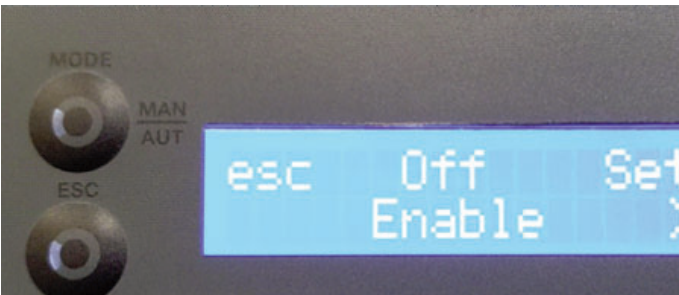

There are 10 weekly programmes available on the Timer see "fixed timer schedules at the back of the manual". The selected programme runs from Monday to Friday and from Saturday to Sunday.

Press "set"; the display starts to flash. Press the "+" or "-" key to select the desired programme and then press "ok" to confirm. Press the "+" key to go to menu "Reset".

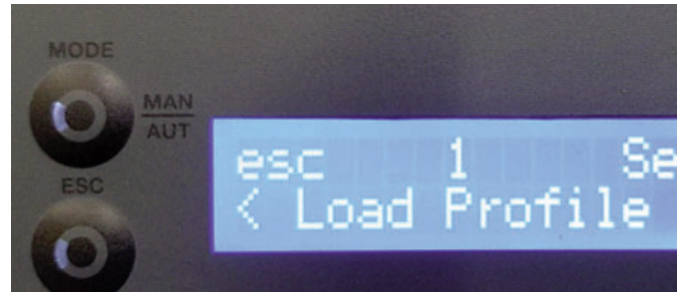

Press the "+" key to go to menu "Reset". This menu allows you to delete any programme settings. To do this, press "set". The "Confirm" appears. Press "set" again to confirm that you want to delete the settings or "esc" to exit.

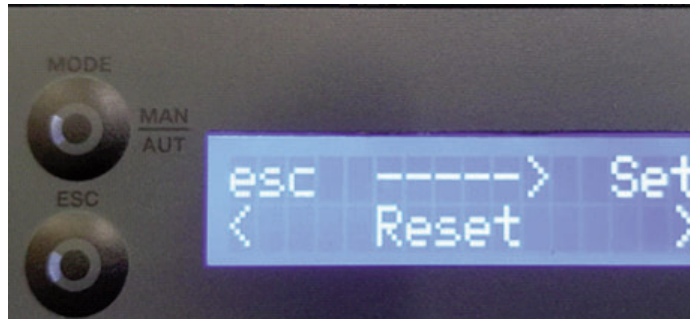

Alternatively the unit's programmer lets you choose from 6 different programmes for each day of the week.

To set up programmes "P1" to "P6", select the desired programme using the "-" and "+" keys, and press "set" to select. The "P1 Enable" menu appears.

To run a user set program P1 the timer/ chrono must be enabled and also the program must be enabled

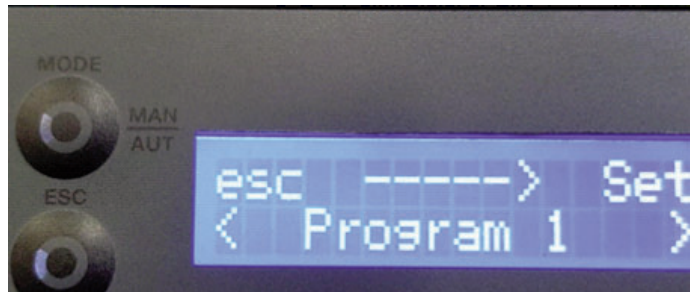

Press "Set" again and when the display starts to flash, press the "+" or "-" keys to select "On" or "Off". Press "ok" to confirm the selection. Press the "+" key to go to the "start" time.



To set the starting time for Programme P1, press "set". The display starts to flash. Press the "+" or "-" key to select the time and then press "ok" to confirm. Press the "+" key to go to the P1 ." Stop" menu.

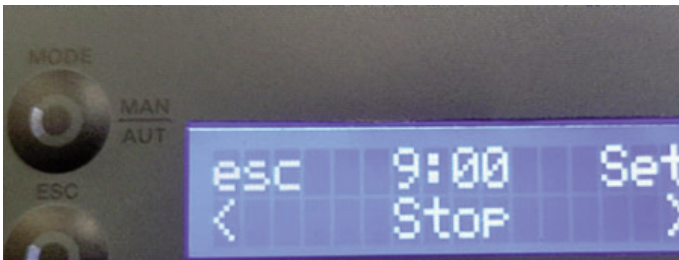

To set the stopping time for Programme P1, press "set". The display starts to flash. Press the "+" or "-" key to select the time and then press "ok" to confirm. Press the "+" key to go to the "Air Temperature "menu.



To set the set point temperature for Programme P1, press "Set". The display starts to flash. Press the "+" or "-" key to select the desired temperature, followed by "Ok" to confirm.

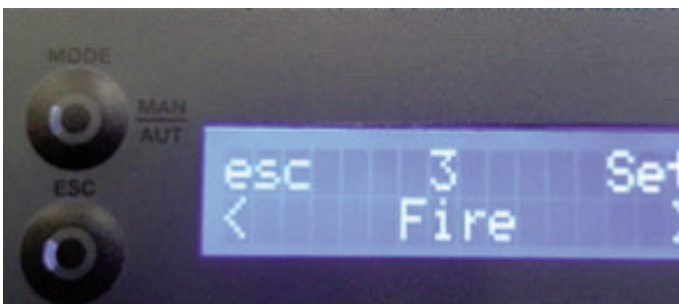

To set the operating power level (1 to 5) of Programme P1, press "Set". The display starts to flash. Press the "+" or "-" key to select the desired power level (1 to 5), and then "Ok" to confirm. Press the "+" key to go to the "Days" menu.

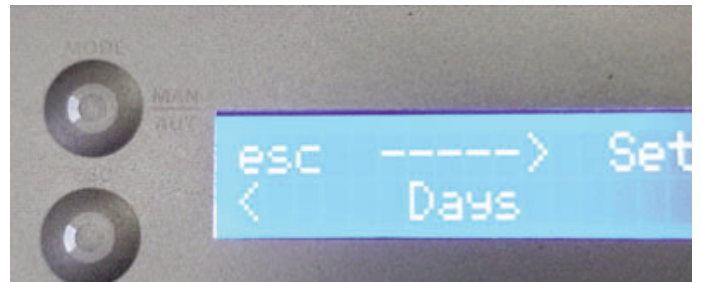

To select the days of the week that you want P1 Programme to run, press "set" and then select the day of the week using the "-" and "+" keys. Press "set". The display starts to flash. Select "On" or "Off" using the "-" and "+" keys. Press "ok" to confirm the selection. Press the "esc" key to go to the "Days" menu. Press the "esc" key again to go to the "program " menu. Press the "+" key to move on to the next menu.

Repeat the steps to set up Programs P2 to P6 or as many as are required.

Once the programs are set remember to "enable" them.

User Information

To access the user information, press “set” twice and then press “+” until “User Info is displayed” press set to access the “User info” then scroll through the following list of parameters using the “+” and “-”.

- Control board code.
- Security code
- Display code
- Parameters
- Functioning time/ run hours
- Service time/ time since last service
- Service time/ time to next service
- Carrying out/ current status
- Exhaust Fan -Rpm
- Consumption pellets- kg/hr
- Fumes/ Flue gas temperature
- Pellet feed time
- Ignitions number

Setting menu,

To access the “settings” press “set” twice and then press “+” until “settings” is displayed.

press “set” to access the “settings” then scroll through the following list of parameters using the “+” and “-”.

- Language
- Eco mode
- Back light
- Remote control
- °C/°F
- Combustion recipe

Language

To select the language, press “set”. Using the “+” or “-” keys, select the language. En – English

Eco mode

When the “ECO” mode is enabled at the same time as the Thermostat feature, the unit will operate at maximum power until the thermostat opens contact (NO). The unit then will operate at minimum power for a pre-set period of time (Shutdown delay time: factory setting: 20 minutes).

Once the pre-set time is elapsed, the unit shuts down. At the start of the Shutdown phase, another timer for a different pre-set period of time is triggered (Start-up delay time: factory setting: 20 minutes), that will make the unit enter the activation phase, when the thermostat closes contact (NC)

Start-up delay time (Delay time On): The delay time that elapses between the moment the thermostat closes (NC) until the unit is activated.

Shutdown delay time (Delay time Off): The delay time that elapses between the moment the thermostat opens (OC) until the unit starts to shutdown.

Note: When using the feature for the first time, you must press the On/Off button in the display. To enable the eco mode, press “set”. The display starts to flash. To activate the eco mode, press "set". The display starts to flash. Select "On" or "Off" using the "-" and "+" keys. Press "set" to confirm the selection.

To Select “ back light” , press “set”. The display starts to flash. Press the "+" or "-" key to select the time for the screen to light up, or select "On" to keep the light permanently on. Press “ok” to confirm.

Remote Control.

This feature enables and disables the remote control, when the user wants to operate the unit's thermostat remotely. Press "Set" and use the "+" and "-" keys to select the "On" or "Off" mode. Press "Ok" to confirm. Press the “+” key to go to the “temperature units” menu.

Note: Some TV remote controls share the same frequency as the unit's remote control, possibly influencing the unit's operation. If this is the case, it is recommended to disable the remote control feature.

°C/°F

To select °C / °F, press “set”. The display starts to flash. Press the “+” or “-” key to select “°C”, “°F” or “Auto”, and then “ok” to confirm.

Combustion settings.

This allows for adjustment of the “pellet” quantity and the “air flow”

Pellet

This feature allows the user to increase or decrease by 25% the pellet quantity during the start-up and power process. Press "set". The display starts to flash. Press "+" or "-" to increase or decrease (between -10 to +10), as required. Each unit must be multiplied by 2.5 to obtain the correct percentage.

Air

This feature allows the user to increase or decrease by 25% the rotation speed of the fume extractor during the start-up and power stages. Press "set". The display starts to flash. Press the "+" or "-" key to increase or decrease (from -10 to +10), as required. Each unit must be multiplied by 2.5 to obtain the correct percentage. Press "ok" to confirm.

Technical menu,

The technical menu is password protected, the password is only provided to authorised technicians.

Operation.

Start up.

After loading the pellets into the hopper , press and hold the ON/OFF button for 3 seconds, to start the stove. During the lighting phase, the display will show the message “Ignition” (until this phase is completed).

The pellets are fed through the supply channel to the burning pot (combustion chamber), where they will be ignited using an igniter. This process may take 5 to 10 minutes, depending on whether the worm screw used to push through the pellets has been previously filled or not. Once the ignition phase is completed, the message "On" appears on the display. The heating power can be adjusted at any time by pressing the power selection button for approximately 1 second. You can select from the five pre-set power levels that are available. The selected power is indicated on the display. The initial power status at each start-up will correspond to the power level set before the last stop.

Note Before starting the machine check that the baffle plate is correctly positioned.

Shut down.

To turn off the pellet stove is carried out by pressing the ON / OFF button for 3 seconds. The display will show “shut down” until full completion of this phase. The extractor will operate until the fume temperature of 64°C is reached, to guarantee that all the material has been burnt.

Note

Do not shut down the appliance by isolating the electrical supply .

CO ALARM

The fitting of CO Alarms in the same room as the appliance is a compulsory requirement under current Building Regulations. For ROI an additional CO Alarm must be fitted either inside each bedroom or within 5 metres of the bedroom door, refer to Building Regulations Part J. Further guidance on the installation of a carbon monoxide alarm is available in BS EN 50292:2002 and from the alarm manufacturers instructions.

Pellet Reservoir / Hopper

To access the pellet reservoir, open the lid on the top of the unit by pushing down and sliding the clip to the left.



The reservoir will hold approx 11 kg, to fill the hopper carefully cut the corner of the bag so the pellets can be poured into the hopper without spilling outside of the rubber seal. Do not pour dust into the hopper as it can impair the feed screw mechanism.

Maintenance

The stove requires careful maintenance see label on the hopper lid, it is recommended to keep a maintenance log as outlined in maintenance log section. The most important thing is to periodically remove the ashes from the pellet burning chamber. For your convenience, you may use a household vacuum cleaner. The cleaning operation must be performed after burning approximately **30kg of pellets**.



Prior to cleaning, the stove must be turned off and allowed to cool to prevent injury.

Glass Cleaning

The glass can only be cleaned when it is completely cold. It must be cleaned with a suitable product in accordance with the instructions for use and care must be taken to prevent the product from reaching the sealing cord and painted metal parts - so as not to cause undesired effects. The rope seal is fixed with adhesive so any contact with water or any other liquids must be avoided. If using a glass cleaning spray, apply the product to a cloth first as opposed to applying it directly to the glass.

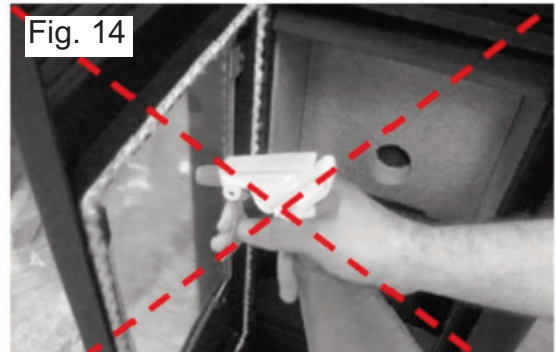

Fig. 14– Incorrect cleaning of the glass



Fig.15 & 16 – Correct cleaning of the glass.

Cleaning the glass:

- moisten a soft cloth with liquid;
- clean the glass using the cloth

Weekly Maintenance/Cleaning the flueways.

For weekly cleaning, open the door remove the burner and clean the ashes from inside the combustion chamber. Also, clean the ashes inside the burner to ensure that the burner holes are completely unobstructed. Put the burner back in place and close the door.



Fig. 17

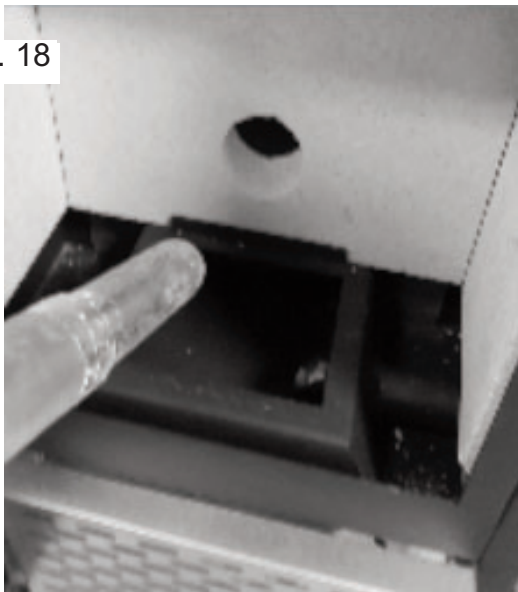

Fig. 18

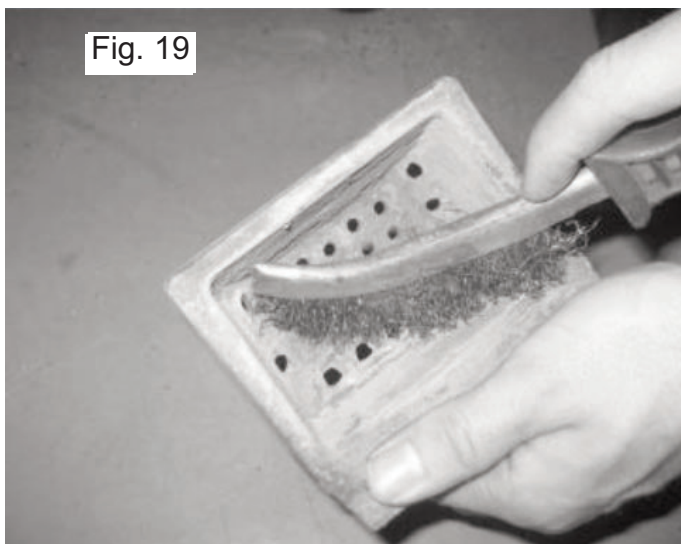

Fig. 19

Note. The frequency of maintenance tasks depends on the quality of the pellets..

Additional cleaning for each 600-800 Kg of pellets consumed.

To clean the flue passageway you must remove the stove top (pull the stove top upwards, it has a spring fit),

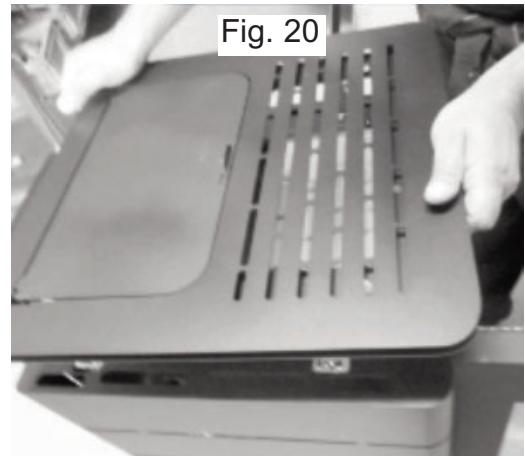

Fig. 20

Also remove the side covers and the lower front grill behind the door by removing the fixing screws.

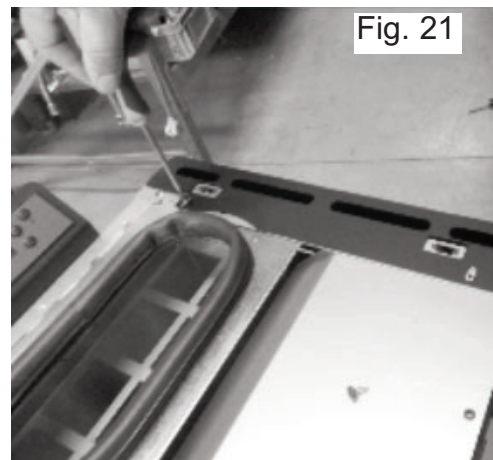

Fig. 21

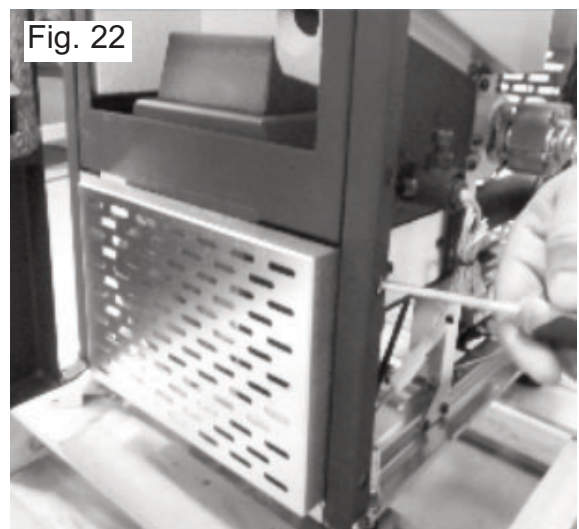
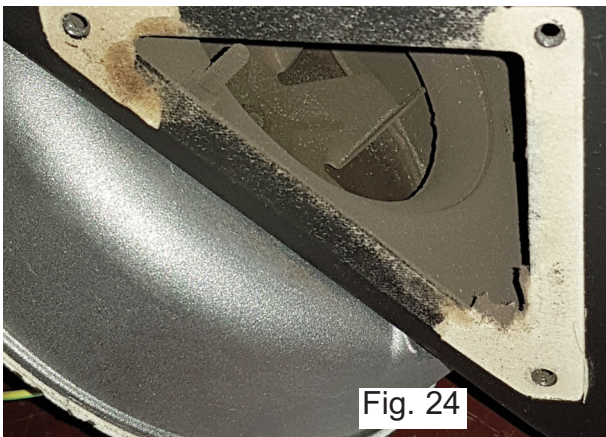
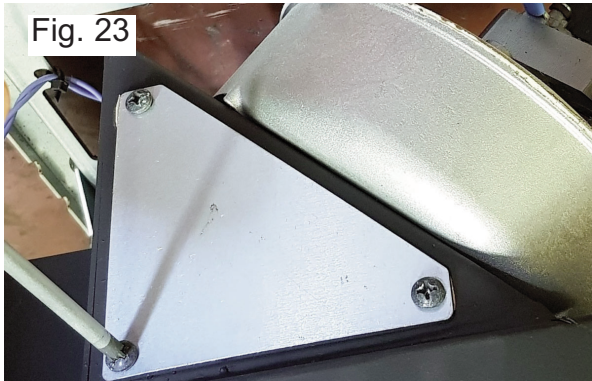
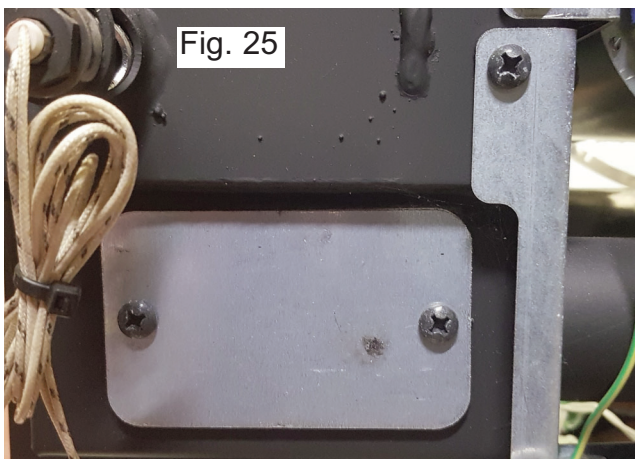

Fig. 22

Once the covers have been removed, remove the side and front covers of the flue passageway.



Front cover removal



The side cover shown above is located on the right hand side of the stove adjacent to the igniter.

Note: Cleaning of flue passageways should be done at least once per year, but also after 800kg fuel usage, in addition if there are any fume extraction problems the flueway should be cleaned. Disconnect the electrical supply prior to cleaning the flueway.

Clean out the ash accumulated inside the flue passageway, if necessary use small brush to remove the most ingrained ash and clean using a vacuum. Replace the parts in reverse order.

Part of the flue passageways are only accessible by removing the flue baffle and the vermiculite in front of it. If necessary remove the side vermiculite liners.



To remove the vermiculite lift it with one hand and the baffle with the other, when both are raised move the vermiculite out over the tab at the bottom edge allowing the vermiculite then be removed. Then remove the flue baffle.



Using a small steel brush (a 20-25mm diameter steel brush) remove the ashes in the flue passageway that are difficult to access and the more ingrained ashes that are found in the walls of the combustion chamber. Use the vacuum cleaner to remove dirt from inside the combustion chamber. Replace the parts in reverse order.

To clean the exhaust pipe and impeller housing it is necessary to remove the fan motor and impeller assembly.

Remove the support leg next to the exhaust fan. At the same time disconnect the temperature probe, the silicone tube and the connecting cables that are attached to the extractor.

Fig. 28

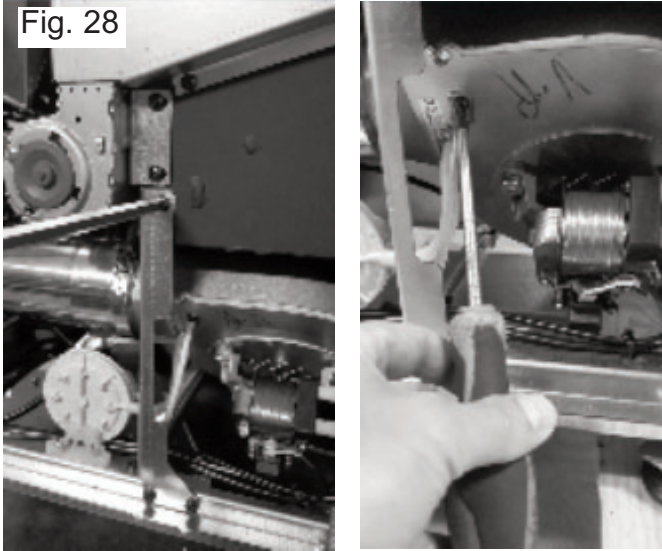

To remove the fan motor and impeller assembly specialist tools will be required to access the least accessible screw. See picture of suitable tool including pz1 screw tip.

Fig. 29

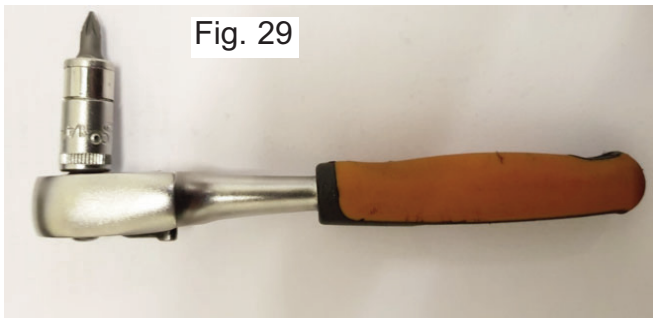

Remove the screws that attach the fan and impeller from the extractor housing, remove the least accessible screw first, with the screws removed the assembly can be lifted clear while taking care not to damage components.

Fig. 30

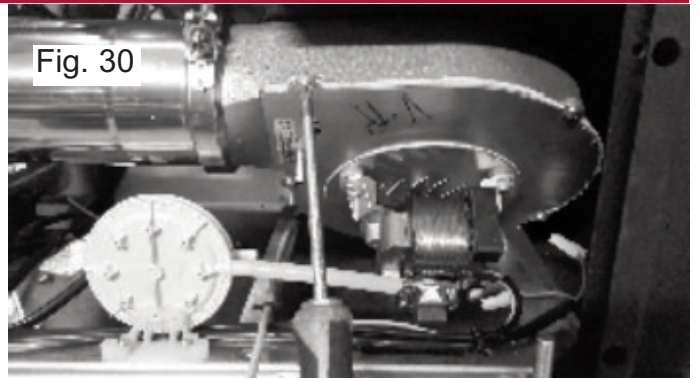
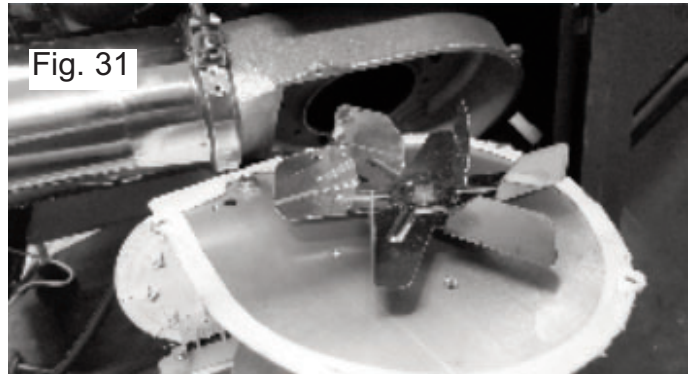

Fig. 31



Using a vacuum cleaner remove the ash that is accumulated in the housing of the extractor, on the impeller and in the flue pipe. After cleaning the various parts of the extractor put them back in reverse order.

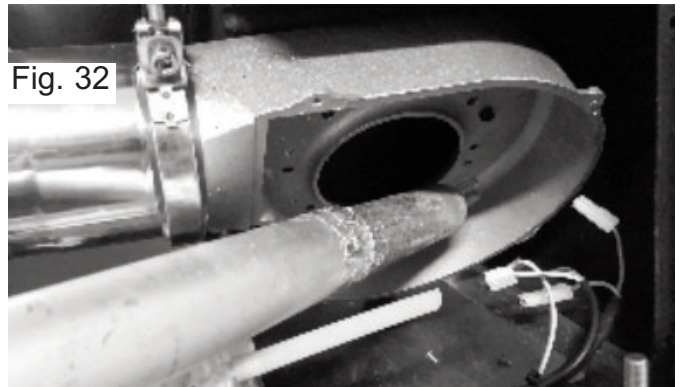
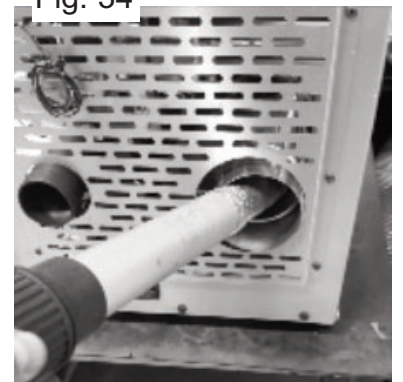

Fig. 32

Fig. 33



Fig. 34



Note

A “service” warning on the display (maintenance due) indicates that the unit has exceeded 2100 operating hours. In this case, the client must perform the unit's maintenance procedure (following the instruction on the Technical Manual). Once this procedure is completed the hour meter may be reset, to clear the warning message. This message does not impact the normal operation of the unit. It is simply a warning.

Note

The errors can be reset only when the error information is flashing on the display. To reset the error, press the “Mode” button once while displaying the error.

Maintenance Plan and Log

To ensure the proper operation of the unit, maintenance operations must be performed, as described in sections “Weekly cleaning” through to “Additional cleaning” of this Instruction Manual . There are specific maintenance tasks that must be performed by authorised technicians only. Please contact the person responsible for installing the unit. To make sure the warranty remains valid, the maintenance operations performed on this unit must comply with the frequency requirement specified in the manual, and the service technician must fill and sign the maintenance log.

Service / Cleaning schedule

Remove ashes from combustion chamber after each burning of 30kg of pellets.

Brush and vacuum all residue from flue passageways after each burning of 600-800kg of pellets.

Full service by Technician including all of the above and cleaning of the flue and flue fan etc must be carried out on an annual basis, full details are provided on the label fixed to the hopper cover.

Company	_____
Engineer	_____
Date	_____
Service hours	_____
Quantity of pellets Burned	_____

Task	Check	Notes /
Clean burner		
Clean flue gas circuit		
Vacuum pellet dust from hopper		
Clean the flue gas fan		
Clean the flue gas Tee piece		

Company	_____
Engineer	_____
Date	_____
Service hours	_____
Quantity of pellets Burned	_____

Task	Check	Notes /
Clean burner		
Clean flue gas circuit		
Vacuum pellet dust from hopper		
Clean the flue gas fan		

Company	_____
Engineer	_____
Date	_____
Service hours	_____
Quantity of pellets Burned	_____

Task	Check	Notes /
Clean burner		
Clean flue gas circuit		
Vacuum pellet dust from hopper		
Clean the flue gas fan		
Clean the flue gas Tee piece		

Troubleshooting guide

Note

When triggered, all the alarms below cause the machine to shutdown. The alarm must be reset and the unit restarted. To reset the unit, press the “On/Off” button for 10 seconds until the alarm sounds.

Alarm	Code		Troubleshooting
Ignition failure	A01	Maximum time 2400 s	<ul style="list-style-type: none"> - the worm drive channel is empty - restart the unit - Igniter failed – replace igniter - burning basket incorrectly installed - Locked worm - unlock - Smoke temperature exceeded the value defined in the software
No flame or insufficient quantity of pellets	A02	Temperature under : - 40 °C (Air Version)	<ul style="list-style-type: none"> - Pellet reservoir is empty
Pellet drum temperature is too high	A03	110 °C	<ul style="list-style-type: none"> - the fan is not working – call for assistance - faulty thermostat - call for assistance - faulty ventilation of the unit
Fume temperature is too high	A04	Over 230 °C (Air version);	<ul style="list-style-type: none"> - the fan is not working or is working at a low speed - increase - Insufficient extraction - Excess pellets - Faulty smoke sensor
Pressure regulator alarm	A05	Door open, draught too low or extractor fault for 60 sec	<ul style="list-style-type: none"> - close the door and clear the error message on the faulty pressure switch - obstruction of the exhaust pipe or faulty extractor
Air mass sensor	A06	40 lpm Delta for 3600 s	<ul style="list-style-type: none"> - Piping with insufficient draft or obstructed tubing
Fume extractor failure	A08	Connection failure	<ul style="list-style-type: none"> - check connection - Check that the fan is not blocked
Fume probe failure	A09	Connection failure	<ul style="list-style-type: none"> - check connection
Pellet resistor failure	A10	Connection failure	<ul style="list-style-type: none"> - check connection - Faulty resistance
Worm drive failure	A11	Connection failure	<ul style="list-style-type: none"> - check connection - Failed worm motor

Exploded view.

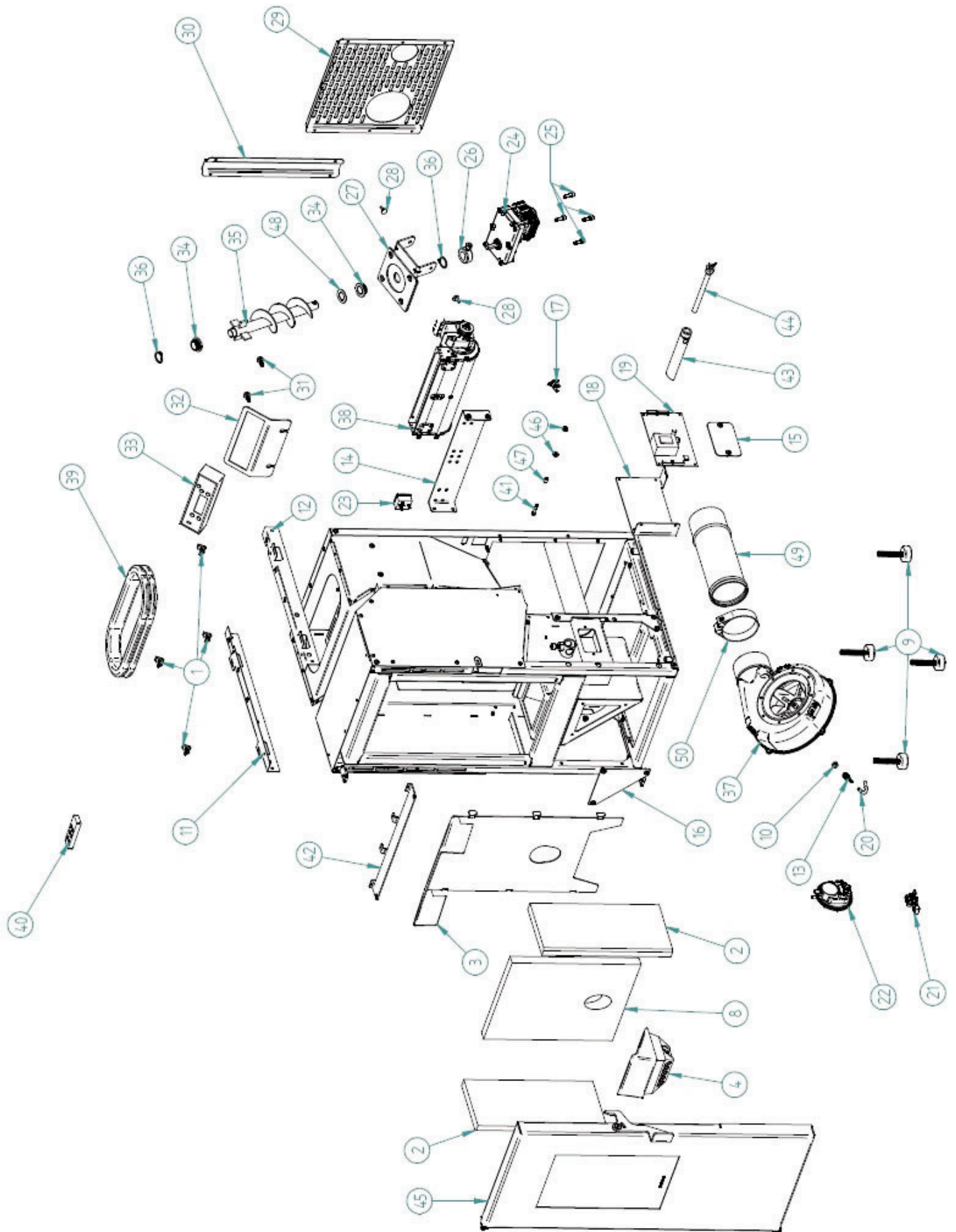

Spare parts list.

ID No.	Part code	Part Description
2	IS1013200000006	vermiculite side pnels
3	IS0101050260032	Smoke deflector
4	IS3525000260003	Burnpot- Crucible
8	IS1012200000004	vermiculite back
9	CO0713001006500	Levelling bolt
14	IS0465000030000	Ventilation fan support
15	IC0416000260001	Side cleaning cover
17	CO0306000000020	Pellet Hopper Thermostat 110°
19	CO0312000000084	Circuit board- Programmer
20	IS1510080000004	Tubo Silicone 8X6X50
21	CO0315000000060	Pressure switch support
22	CO0315000000030	Pressure Switch
23	CO0312000001000	Back source PG500
24	CO0310000000150	Motor worm screw
28	CO0728000000000	Rubber motor stop
33	CO0312000000032	Display panel
37	IC0490000000004	Extractor fan k100
38	CO0308000000013	Ventilation fan.
42	IS0232015300005	Front Deflector
44	CO0303000000050	Igniter Steel
45	IC0420000260062	Complete Door
48	IS0899012000000	Stainless washer
51	CO0312000000009	Encoder board
53	CO1206020000003	Extractor fan - gasket
	IS2030040400042	Door Glass

Ignition logic flow diagram

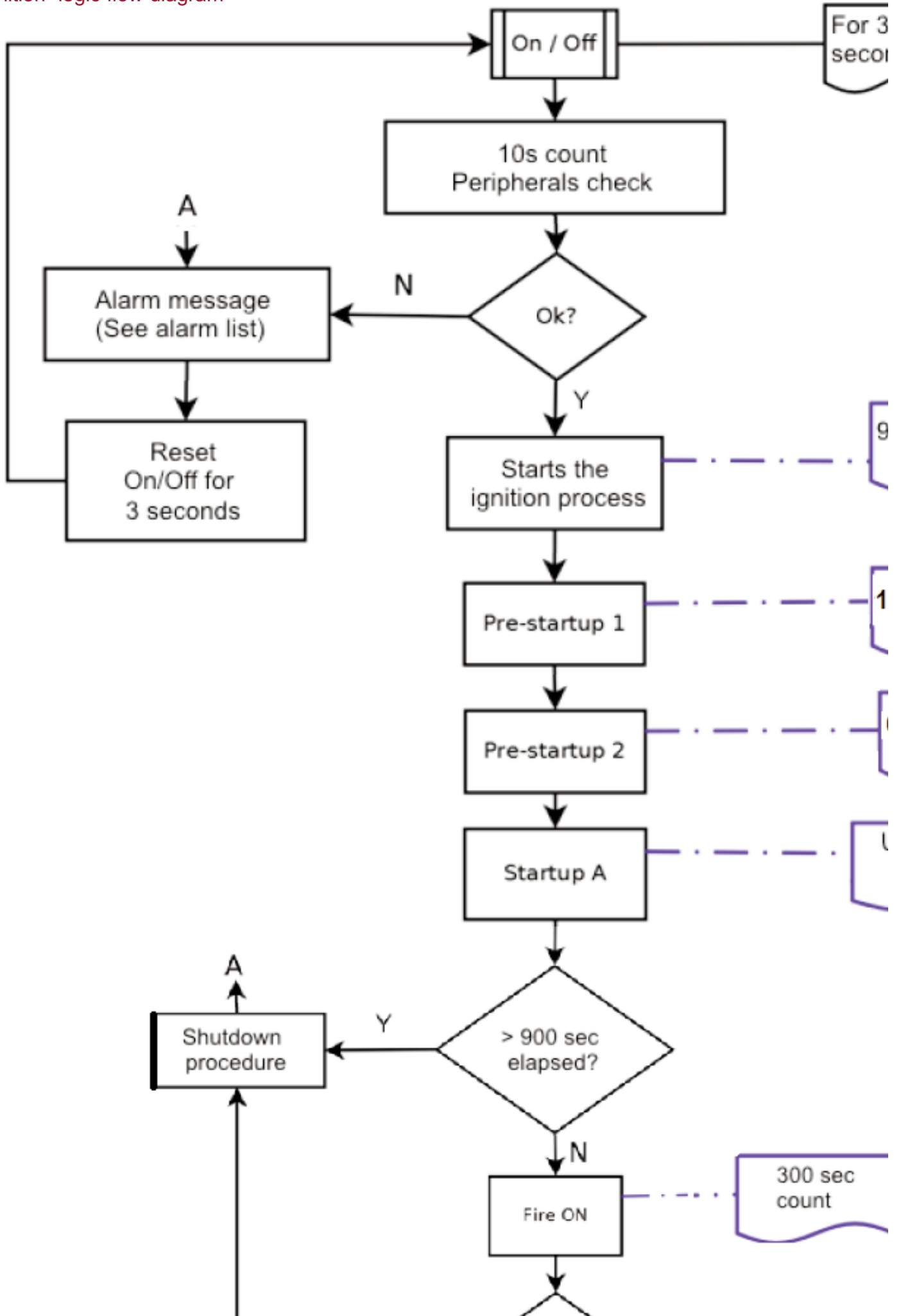

Shut down logic flow diagram

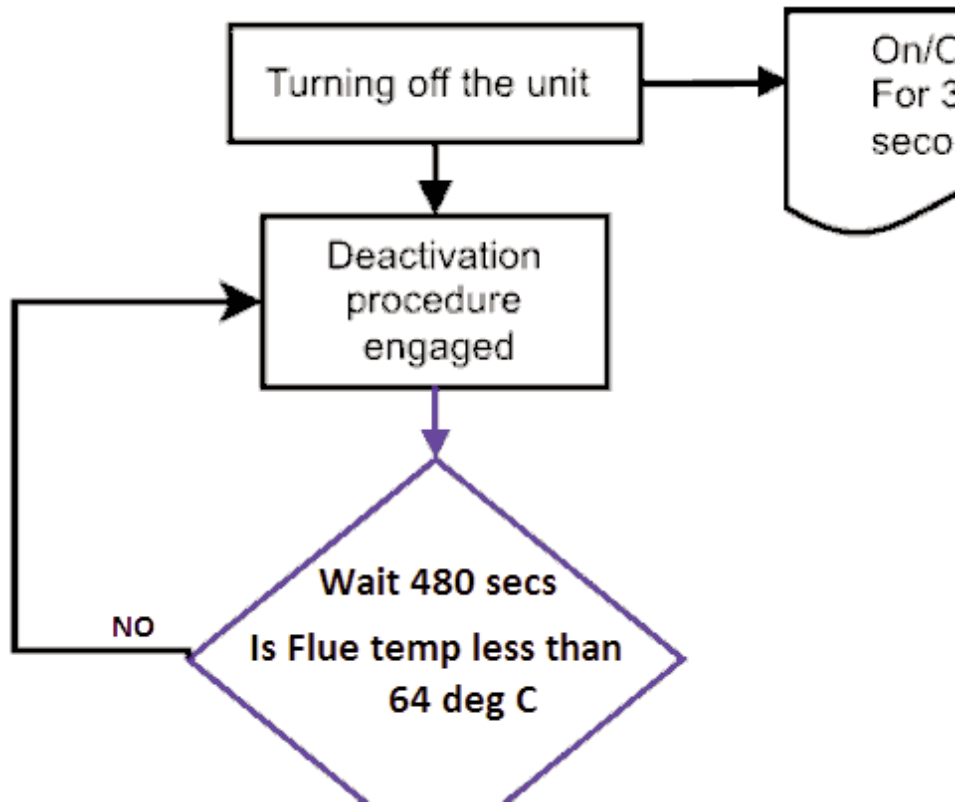

Fixed timer program schedules

Prog No.	Days	Daily programming																							
		0	1	2	3	4	5	6	7	8	9	10	11	12	13	14	15	16	17	18	19	20	21	22	23
P01	Mon-Fri																								
	Sat-Sun																								
P02	Mon-Fri																								
	Sat-Sun																								
P03	Mon-Fri																								
	Sat-Sun																								
P04	Mon-Fri																								
	Sat-Sun																								
P05	Mon-Fri																								
	Sat-Sun																								
P06	Mon-Fri																								
	Sat-Sun																								
P07	Mon-Fri																								
	Sat-Sun																								
P08	Mon-Fri																								
	Sat-Sun																								
P09	Mon-Fri																								
	Sat-Sun																								
P10	Mon-Fri																								
	Sat-Sun																								



Manufactured by
Waterford Stanley Ltd.,
 Unit 401-403, IDA Industrial Estate, Cork Road,
 Waterford, Ireland.
 Tel: (051) 302300